

# Vaporella®

*Professional System*

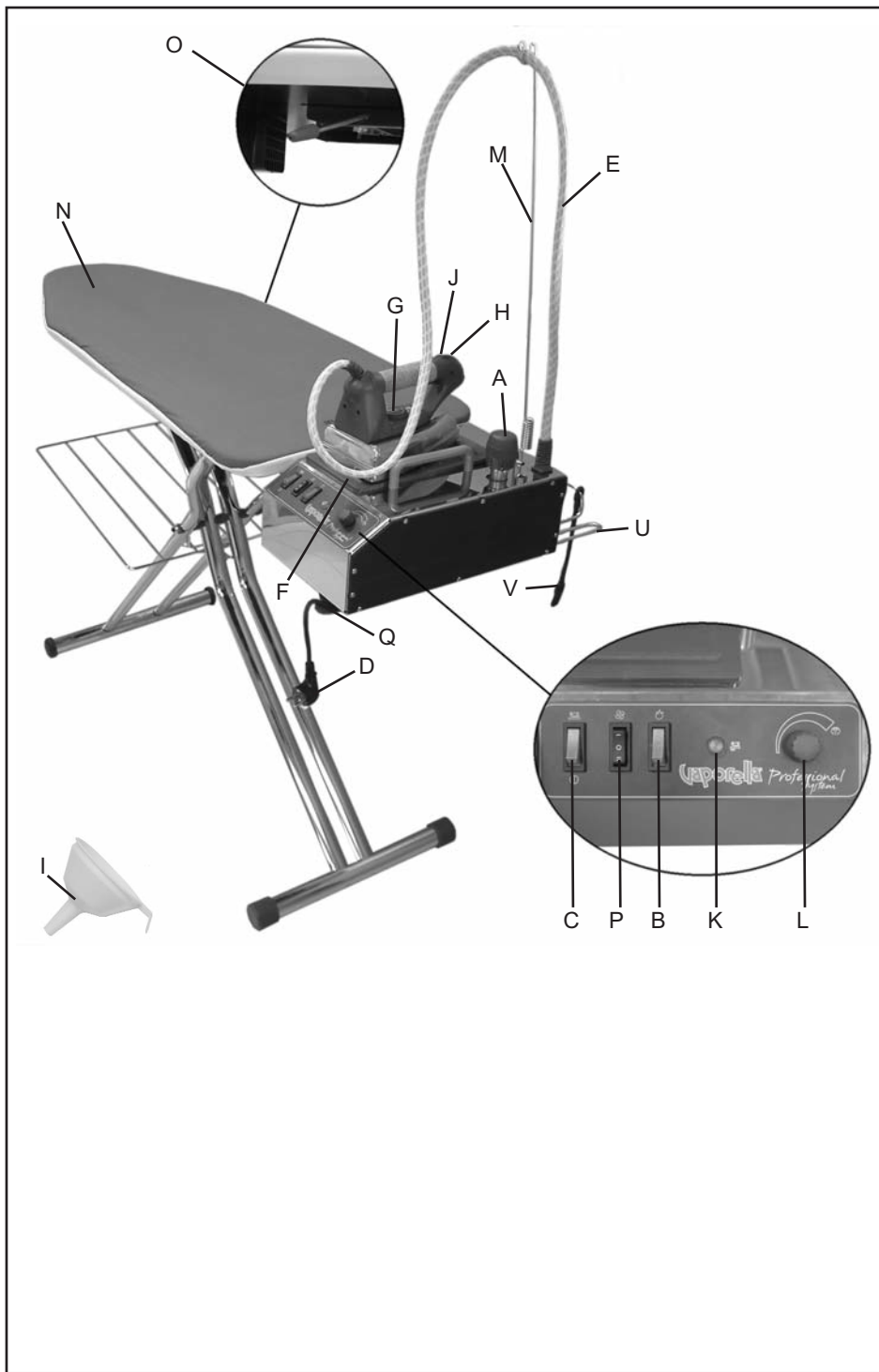

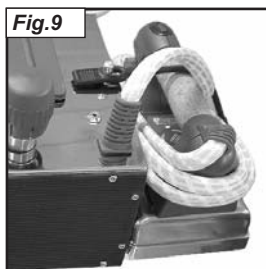

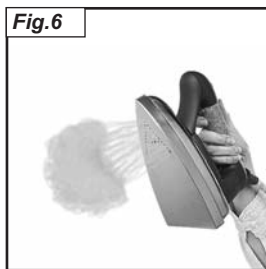
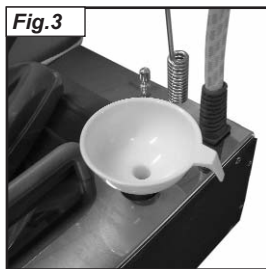
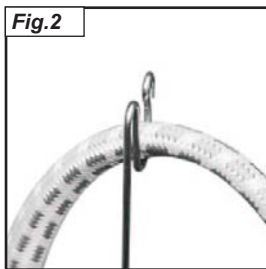
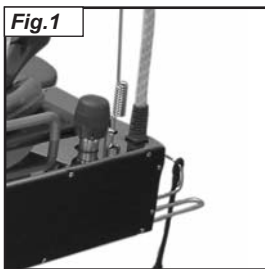
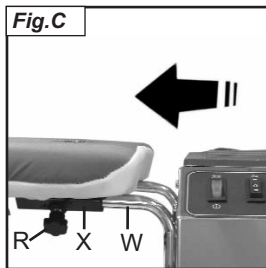
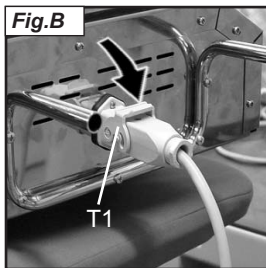
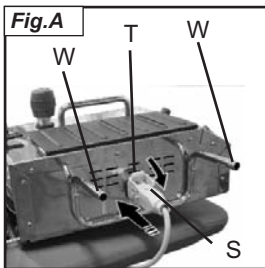

# VAPORELLA PROFESSIONAL SYSTEM



Read these instructions carefully before using the appliance.

Dear Customer,  
thank you for the confidence you have placed in Polti buying this product.

Vaporella Professional System is a boiler iron for domestic use, equipped with a heated, blowing, vacuum press ironing board for professional results.

Vaporella allows you to **achieve** perfect ironing, saving time and effort. With **professional iron** it is not necessary to press or iron over repeatedly but just let the iron slide gently over the fabric. The pressure of the steam produced in its boiler gets right into the fibres, eliminating every crease in just one single pass. The steam power is so strong that you can even iron more than one side of a fabric at a time (making ironing sheets for example many times faster)

The **ironing board** has a solid metallic frame which can be adjusted in height and with its large working surface it is a perfect complement to the powerful steam produced in the boiler. The **heating** function dries the fabrics and makes the ironing easier, faster and effortless. The **suction** keeps the fabric stuck to the board, preventing the formation of creases which rise up easily with other ironing boards. The **airing** function inflates delicate fabrics so that it is possible to iron over with steam power only.

Vaporella Professional System helps you to work safely. This product conforms with very strict regulations and is equipped with exclusive **safety devices**, among them the patented **safety cap**, which prevents the device being opened accidentally as long as there is slightest pressure inside the boiler.

## KEY

- A) Patented safety cap
- B) Generator on/off switch (illuminated)
- C) Iron on/off switch (illuminated)
- D) Power supply cable
- E) Monoflex (power and steam)
- F) Heat resistant iron rest
- G) Iron temperature control
- H) Steam on/off button
- J) Continuous steam jet button
- K) Pressure indicator light
- I) Funnel
- L) Steam flow regulator
- M) Flex holder
- N) Ironing surface
- O) Opening handle
- P) Function switch:
  - heating system
  - I blow function + heating
  - II suction + heating
- Q) Supply cable storage
- R) Locking devices (fig. C)
- S) Board connector (fig. A)
- T) Vaporella connector (fig. A)
- T1) Safety device for connector (fig. B)
- U) Iron stand surface
- V) Iron fixing belt
- W) Metal fixing pins (fig. C)
- X) Fixing tubes (fig. C)

 This unit conforms with EC-directives 89/336 as amended by 93/68 (EMC) and 73/23 as amended by 93/68 (low voltage).

Politi S.p.A. reserves the right to change equipment or accessory specification without prior notice.

## PLEASE READ THE FOLLOWING BEFORE USE

### KEEP THESE INSTRUCTIONS

- Read these instructions for use carefully before using the appliance.
- Use which does not comply with these instructions will invalidate the warranty.
- The wiring system to which the appliance is connected must always comply with the laws in force.
- Before connecting the appliance, make sure that the mains voltage is the same as the voltage indicated on the data label of the appliance and that the power outlet is connected to earth
- Always turn off the appliance at the on/off switch before unplugging it.
- If the appliance is left unused, always disconnect it from the mains. Never leave the appliance unattended with the cable plugged into the mains.
- Always make sure the appliance is unplugged before performing maintenance work of any kind
- Do not pull the power cable out of the socket, but grasp the plug itself to avoid damage to the socket.
- Do not allow the power cable to be twisted, crushed, stretched, or come into contact with sharp or hot surfaces.
- Do not use the appliance if the power cable or other important parts are damaged.
- Do not use electric extension leads that are not authorized by the manufacturer, as they may cause damage or fire.
- If it is necessary to replace the power supply cable, please refer to the nearest Polti authorised service centre, since the use of a special tool is necessary.
- Never touch the appliance with wet hands or feet with the cable plugged into the mains.
- Do not use the appliance when barefoot.
- Do not use the appliance near a bathtub, shower or container full of water
- Never immerse the appliance, the cable or the plugs in water or other liquids.
- Use of the appliance in places where there is a danger of explosions is prohibited.
- Do not use the product with toxic substances.
- Do not lay the hot appliance on surfaces sensitive to heat.
- Do not leave the appliance exposed to wind or rain.
- Do not place the appliance near a live element, an electric stove or any other source of heat.
- Do not expose the appliance to extreme temperatures
- Never let children or people who are not familiar with how the appliance works use it.
- Do not press the buttons hard or with a pointed object such as a pen.
- Always rest the appliance on a stable surface.
- In case of accidental fall of the appliance it is necessary to have it checked by an authorized Service Centre as the internal safety features may have been affected.
- In case of breakdown or malfunction switch off the appliance and never attempt to disassemble it, but refer to an authorized Service Centre.
- In order to avoid prejudicing the safety of the appliance, use only original spare parts and accessories approved by the manufacturer.
- Do not wind the power cable around the appliance, especially when the appliance is still hot.
- During refilling with water, switch off and disconnect the appliance from the mains.
- It is necessary to keep the unit in horizontal position during operation.
- Do not direct the steam jet on electrical and/or electronic appliances.
- Let the appliance cool down before cleaning it.
- Before storing the appliance make sure that it has completely cooled down.
- This appliances is equipped with safety devices which are to be replaced only by a suitably qualified technician.
- Do not direct the steam jet at people, animals or debris. **Danger of burns!**
- Never place your hands inside the jet of

## steam. **Danger of burns!**

- Do not put any detergent or chemical substance in the boiler. Water by its nature contains magnesium, mineral salts and other deposits which in hard water areas can contribute to limescale build up in the tank. In very hard water areas we recommend the use of our KALSTOP FP 2003, a special natural-base decalcifier which inhibits and breaks down limescale. This is a preventive against scale build-up and protects the metal walls of the boiler. KALSTOP is available from Polti dealers or from your Polti Service Centre.
- If you iron sitting down, do not place your legs under the ironing board, the steam can cause burns.
- Iron only on heat resistant surfaces and on surfaces that allow the steam to escape e.g. mesh ironing boards.
- For iron rest replacement use only original spare parts.
- The iron must be used and rested on a stable surface.
- When placing the iron on its stand, make sure that the surface on which the stand is placed is stable.
- Activate the automatic closing hook lever (O) only if the board is resting horizontally on the ground; during closing, always support the board until it reaches the floor.
- If in the future you need replace the ironing board fabric cover or the lining, always be sure that the replacement is permeable to humidity. Humidity resistant fabrics can be damaged by heat or moisture.
- Check that the continuous steam request button is switched off before connecting the appliance to the mains.
- This appliance is not intended for use by persons (including children) with reduced physical, sensory or mental capabilities, or lack of experience and knowledge, unless they have been given supervision or instruction concerning use of the appliance by a person responsible for their safety.
- Children should be supervised to ensure that they do not play with the appliance.

## CORRECT USE OF THE PRODUCT

This appliance is intended for home use as a steam generator as described and in accordance with the instructions provided in this manual.

Please read these instructions carefully and keep them, as you may find them useful in future.

**Polti Spa declines liability for any damage or accident derived from any use of VAPORELLA which does not comply with the instructions contained in this booklet.**

## ATTENTION

Directive 2002/96/EC (Waste Electrical and Electronic Equipment - WEEE): information for users

This product complies with EU Directive 2002/96/EC.



The crossed-out wastebasket symbol on the appliance means that at the end of its useful lifespan, the product must be disposed of separately from ordinary household wastes.

The user is responsible for delivering the appliance to an appropriate collection facility at the end of its useful lifespan.

Appropriate separate collection to permit recycling, treatment and environmentally compatible disposal helps prevent negative impact on the environment and human health and promotes recycling of the materials making up the product. For more information on available collection facilities, contact your local waste collection service or the shop where you bought this appliance.

## IMPORTANT

Before leaving our factory all our products are rigorously tested. This is the reason why your VAPORELLA may contain some residual water in the boiler.

# VAPORELLA PROFESSIONAL SYSTEM

## HOW TO CONNECT/DISCONNECT VAPORELLA TO THE BOARD

To assemble the Vaporella to the board proceed as follows:

- Place Vaporella on to the board so that the fixing pins (**W**) are directed outwards (Fig.A).
- Insert the board connector (**S**) into the Vaporella connector (**T**) to make the electrical connection.
- To fix the connection, lower the locking device (**T1**) located on the Vaporella connector (Fig. B) until it locks.
- Turn the Vaporella and insert the two fixing pins (**W**) into the tubes under the board (**X**) pushing it until it locates securely into the board (Fig. C).
- Screw up the two locking devices (**R**) to fix the Vaporella to the board.  
Before using Vaporella carefully check that it is correctly connected to the board.
- To disconnect Vaporella proceed inversely to the above description.

**NOTE:** while connecting and disconnecting Vaporella place the iron on the right iron stand (**U**) As described in paragraph "how to close the machine".

## PREPARATION FOR USE

- 1a. Rest the board on the floor.
- 2a. Pull the opening handle (**O**) upwards and open the board (**N**), supporting it as it rises to the right height position. Adjusting the regulation handle (**O**), you can bring the board up to the required height.
- 3a. Insert the cable stand (**M**) in its location (fig. 1).
- 4a. Place the cable (iron power supply - steam tube) (**E**) in its support (fig. 2). The appliance is also equipped with a rigid iron rest (**F**).
- 5a. Unscrew the patented safety cap (**A**) and fill the boiler with about 0,9 litres of water using the special funnel (**I**) making sure that it does not overflow (fig. 3). Normal tapwater can be used. However, as hard water by its nature contains limestone, which may cause a build-up of limescale





in the tank, in hard water areas we recommend the use of our natural-base decalcifier KALSTOP FP 2003.

- 6a. Retighten the cap fully and carefully.  
Ensure the patented safety cap is fully and correctly screwed on, otherwise you may experience steam escaping from around the cap.
- 7a. Connect the power supply cable (**D**) into an earthed power supply of the correct voltage.
- 8a. Switch on the boiler and iron by pressing the switches (**B**) and (**C**) which will light up together with the pressure indicator light (**K**) (fig. 4).
- 9a. Wait for a few minutes to allow the ironing surface to reach the operating temperature.
- 10a. By pushing the function switch (**P**) (Fig.4) on position (**I**), the board will allow you to swell the clothes with a "hot blow", in order to be able to gently skim with the iron the most delicate clothes, ironing them with steam only.
- 11a. By pushing the function switch (**P**) (Fig.4) on position (**II**), the board will hold the clothes to the surface and eliminate the residual humidity.

**Note:** to avoid condensation inside the ironing board we recommend you always use the suction function while steam ironing.

## INSTRUCTIONS FOR USE

Check the manufacturer's label on the garment, and interpret the symbol on the label as follows:

	Steam ironing allowed For dry ironing, set the iron temperature on ...
	Steam ironing allowed For dry ironing, set the iron temperature on ..
	Check the fabric's resistance to steam ironing, dry ironing allowed with temperature set on •
	- do not iron - steam ironing or treatment not allowed

## STEAM IRONING

- 1b. Set the iron temperature to the "COTTON - LINEN" steam position (fig. 5), by turning the knob (G). All types of fabric can be ironed at this temperature. When dry ironing, set the knob (G) to the required temperature for the fabric, shown on the rotating indicator.
- 2b. Wait for the pressure indicator light (K) to go out (about 15 minutes). Push button (H) on the iron to release bursts of steam from the holes on the soleplate. Release the button and the steam will stop (fig. 6). **NOTE:** during initial operation of the iron, a few drops of water mixed with steam may come out of the soleplate until the temperature stabilises. It is advisable to direct the first jets of steam onto an old cloth until a uniform stable jet of steam is obtained.
- 3b. In order to have a continuous steam jet, move the button (J) forwards. Steam will keep on coming out, even releasing the button. To interrupt the outlet, move the button (J) backwards (fig. 7).
- 4b. By turning the steam flow control knob (L) you can vary the amount of steam according to the type of textile to be ironed (more or less delicate). You can use this control to increase the steam flow by turning in anti-clockwise direction. Turning the control in anti-clockwise direction reduces the steam flow (fig. 8).

### NOTE:

- The pressure indicator light (K) may go on and off from time to time during use of Vaporella. This indicates the machine maintaining the correct and constant pressure and is quite normal.
- If no steam is released from the iron, check the following: the switch (K) is lit up; there is water in the boiler; the steam control switch (L) is set to one of the "Steam" settings.

## HOW TO CLOSE THE MACHINE

- 1d. Turn off switches (B-C-P).
- 2d. Disconnect the supply plug. Rewind the supply cable (D) to its storage (Q).
- 3d. Pull the opening handle (O) and support the board (N) as it descends to the floor.
- 4d. If you want to fold up the iron board with Vaporella attached, it is advisable to place the iron on the iron stand (U) in the following way:
  - take out the iron stand (U) pulling it from the back of Vaporella.
  - Place the iron on the iron stand (U) and fix it with the fixing belt (V) hooking it to the pin on the Vaporella (fig. 9).
  - Winder the main cable (D) in its housing (Q).
- 5d. The ironing board can now be stored. **NOTE:** the iron board and the Vaporella can be folded up separately.



## **PATENTED SAFETY CAP / "WATER OUT"**

All Polti machines are equipped with the unique Polti patented safety cap, which prevents opening of the generator tank as long as there is any pressure remaining inside the tank. This is an important and indispensable safety device, and it is necessary to follow certain procedures when re-filling the tank.

Whenever when you have used up all the water in the tank, do as follow :

- 1e. Switch off the machine at the generator on/off switch **(B)**.
- 2e. Press the steam request button on the iron **(H)** so as to fully exhaust the steam supply from the tank.
- 3e. Disconnect the power supply cable **(D)** from the mains.
- 4e. Unscrew anti-clockwise the patented safety cap **(A)**.
- 5e. Wait for a few minutes to allow the generator tank to cool down.
- 6e. When cool proceed to carefully refill the tank as described in paragraph 3 of the section "PREPARATION FOR USE" in the instructions. If refilling the generator hen not completely cooled, we recommend that you carefully pour only very small quantities of water at each pouring into the tank, so as to avoid spitting from the tank.

## **CARE OF YOUR VAPORELLA**

- **Before attempting any maintenance operation, always disconnect the appliance from the mains.**
- To clean the body of the appliance, simply use a moist cloth. Do not use solvents or detergents which may harm the body material.